

AURORALIGHT

PROJECT: _____

SKU #: _____

TYPE: _____

SONOMA

IGR035001

The Sonoma directional marker is a high flux; low wattage LED luminaire. Coupled with a brass body, our Thermally Integrated® LED Module provides superior heat dissipation, longer life, and higher performance.

- Thermally Integrated® w/ Copper Core Technology®
- Cree LED™ XLAMP® Extreme High Power (XHP)
- IC Rated for Interior, Exterior and Wet Location Use
- Ideal for driveways, wide pathways & walkways

CONFIGURATOR:

IGR035001	LED	FINISH
	<input type="text"/>	<input type="text"/>
() = Most common configuration	(2704) 2700K 4W (3004) 3000K 4W	(NAT) Natural Brass (BLP) Bronze Living Patina (BLPX) Extra Dark BLP (NI) Nickel PVD



AVAILABLE FINISHES:



FIXTURE DIMENSIONS	D3-5/8" x H1-7/8"
LIGHT SOURCE	Integrated LED
COLOR TEMPERATURES	2700K, 3000K
WATTAGES	4W
CRI (RA)	80 CRI
VOLTAGE	12V
DELIVERED LUMENS	16lm (3000K)
DIMMABLE	Yes, Dim to <10% via Transformer
DRIVER	Yes, 12V Integral Constant Current
TRANSFORMER	12V AC/DC (Supplied by others)
MOUNT	Included CJB112105
BEAM SPREAD	90°
FINISH	Included Natural Brass
MATERIAL	Brass & Copper
WIRE LENGTH	24"
LOCATION	Interior & Exterior Wet
CERTIFICATIONS	UL, IP66, IP67, IC, Drive Over

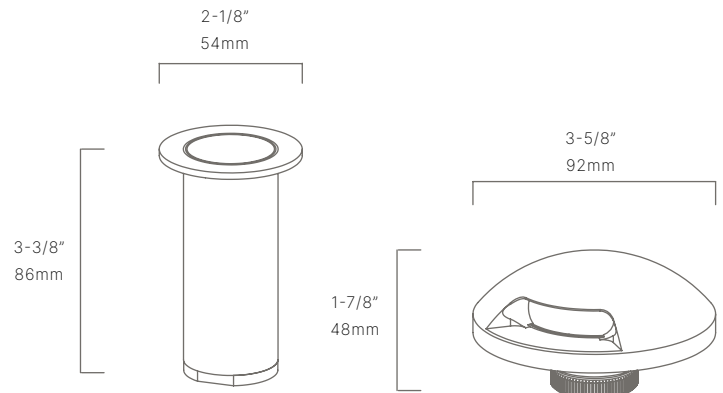

*For complete warranty terms, please visit: www.auroralight.com/warranty/

P. 760.931.2910

O. 2742 Loker Ave. W Carlsbad CA 92010

W. www.auroralight.com

MADE IN USA
WITH DOMESTIC & IMPORTED MATERIALS



AURORALIGHT

PROJECT: _____

SKU #: _____

TYPE: _____

ADD-ONS

MOUNTS

SCE008	Side Conduit Entry
MJB112402	Micro J-Box
MJB112503	Micro J-Box w/ Flush Mount

*For complete details, please visit auroralight.com/mounts/

MOUNTS

